

**Southern
Regional
Aquaculture
Center**

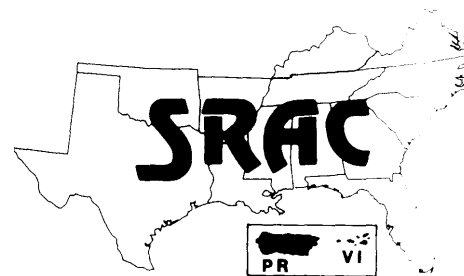

August 1991

Calculating Area and Volume of Ponds and Tanks

Michael P. Masser and John W. Jensen*

Good fish farm managers must know the area and volume of all ponds and tanks. Exact measurement of area and volume is essential in order to calculate stocking rates and chemical applications. Stocking fish into a pond of uncertain area can result in poor production, more disease and possibly death. Chemical treatments can be ineffective if volume/area is underestimated and potentially lethal if it is overestimated.

Measurements and calculations described in this publication can be made in either English or metric units. All examples are given in English units. Conversion tables are provided (at the end of this fact sheet) for those who wish to use metric units.

Calculating area

Surface area calculation is an essential first step. Pond stocking rates, liming rates and other important management decisions are based on surface area. An error in calculating surface area will inevitably lead to other problems. Measure distances accurately, calculate area and double check all calculations.

You may not need to measure pond area yourself.

* **Alabama** Cooperative Extension Service

The contractor who built the pond should have accurate records on pond area. The county field office of the U.S. Department of Agriculture Soil Conservation Service (SCS) assists with the construction of many ponds and has engineering records on many ponds in each county. Also, the county offices of the SCS and the USDA Agricultural Stabilization and Conservation Service (ASCS) have aerial photos from which pond area can be estimated.

Surveying ponds using a transit is the most accurate way to determine area. Less accurate but acceptable methods of measuring pond area are chaining and pacing. Inaccuracies in these methods come from mismeasurements and measurement over uneven/sloping terrain. Measurements made on flat or level areas are the most accurate.

Chaining uses a measuring tape or other instrument of known length. Stakes are placed at each end of the tape. The stakes are used to set or locate the starting point for each progressive measurement and to maintain an exact count on the number of times the tape was moved. Sight down the stakes to keep the measurement in a straight line. The number of times the tape was moved multiplied by

the length of the tape equals total distance.

Pacing uses the average distance of a person's pace or stride. To determine your pace length, measure a 100-foot distance and pace it, counting the number of strides. Pace in a comfortable and natural manner. Repeat the procedure several times and get an average distance for your stride.

For example, if it took you 38, 39 and 40 paces to walk a measured 100-foot straight line then the average was 39 paces $(38 + 39 + 40 \div 3)$. To get the length of your average pace divide 100 feet by 39 paces $(100 \text{ ft} \div 39 \text{ paces} = 2.56 \text{ feet per pace})$. Now, whenever you pace a distance, simply multiply the number of paces by 2.56 to get the distance.

The formula for calculating distances from pacing is:

$$\text{Distance (feet)} = \frac{\text{Total Number of Paces} \times \text{Length of Average Pace}}{\text{Length of Average Pace}}$$

It is a good idea to always pace a distance more than once and average the number of paces.

Square or rectangular ponds

Ponds built in square or rectangular shapes are the most easily

measured. Square and rectangular areas are determined by multiplying length by width. Figure 1 illustrates some typical shapes and sizes of ponds.

In this example the area of the rectangular pond is 75,000 square feet or approximately 1.7 acres.

Areas of ponds which are almost square or rectangular can be esti-

(140 + 162 ÷ 2)) square feet or 1.72 acres.

Other pond shapes

Other formulas are used to calculate ponds that are circular and triangular. Even if your pond is not an exact shape, it may be possible to get a reasonable estimate of its area by using one or a combination of these formulas.

Circular pond areas are estimated by the formula:

$$\text{Area} = 3.14 \times \text{radius}^2$$

(Radius is one-half the diameter.)

For example, a circular pond with a radius of 75 feet has an area of 17,663 square feet (3.14 x 75x 75) or 0.4 acres.

The radius can be measured directly or the diameter can be divided by 2. A measurement of the diameter in several directions will help to determine if the pond is truly circular.

Triangular pond areas are estimated by one of two formulas depending on whether the triangle has a square or 90° angle for one of its corners. If a 90° angle is present the formula is:

$$\text{Area} = 1/2 \times \text{length} \times \text{width}$$

For example, a triangular pond with a length of 250 feet and a width of 220 feet has an area of 27,500 square feet (250 x 220 ÷ 2) or 0.63 acres. It is important to remember that the longest side (the hypotenuse) is not needed for the calculation, instead the two sides that touch the 90° angle are used.

If no 90° angle is present and the sides are unequal, the formula is:

$$\text{Area} = \sqrt{S(S-A) \times (S-B) \times (S-C)}$$

where S = 1/2 (A+B+C)

and A, B and C are the lengths of the sides,

For example, a triangular pond with three sides of 80, 90 and 130 feet has an area of 3,549.6 square feet (where S = 150; and

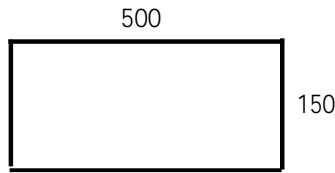

Rectangle or Square - opposite sides same length

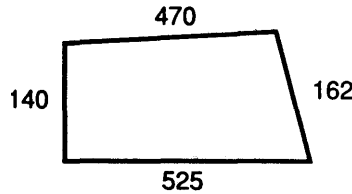

Almost Square or Rectangular - opposite sides approximately same length

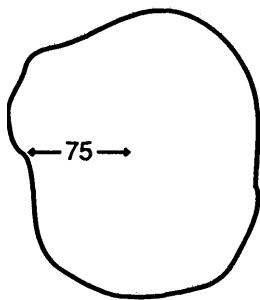

Circular

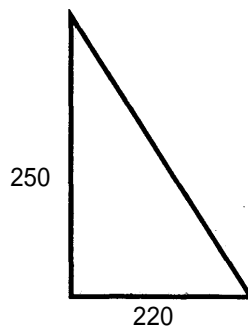

Triangular with 90° angle

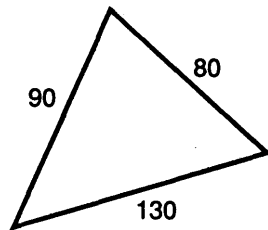

Triangular without 90° angle

Figure 1. Common pond shapes. Dimensions given are for calculating the area of these shapes as described in the text.

Rectangular pond areas are estimated by the formula:

$$\text{Area} = \text{length} \times \text{width}$$

Area of the rectangular pond in Figure 1 is:

$$\text{Area} = 500 \times 150 = 75,000 \text{ square feet}$$

To convert from square feet (ft²) to acres, divide by 43,560 (from Table 1).

$$\text{Area} = 75,000 \div 43,560 = 1.72 \text{ or } 1.7 \text{ acres}$$

mated by calculating average length and width measurements. If we designate the lengths as A and B, and the width as Y and Z then the formula for the area is:

$$\text{Area} = \frac{A+B}{2} \times \frac{Y+Z}{2}$$

For example, an almost rectangular pond that is 470 feet on one side and 525 feet on the other long side, and 140 feet on one end and 162 feet on the other end, has an area of 75,123 ((470 + 525 ÷ 2) x

$\sqrt{150(150-80) \times (150-90) \times (150-130)}$
 or 0.08 acres).

Irregularly shaped ponds

Many ponds in the Southeast are watershed ponds that have been built by damming valleys. These ponds are usually irregular in shape. Check first with your county SCS office for records on your pond, or for aerial photos in the SCS or ASCS office. If no good records exist then a reasonable estimate can be made by chaining or pacing off the pond margins and using the following procedures to calculate area.

1. Draw the general shape of the pond on paper (graph paper works best).
2. Draw a rectangle on the pond shape that would approximate the area of the pond if some water was eliminated and placed onto an equal amount of land. This will give you a rectangle on which to base the calculation of area (See Figure 2 below).
3. Mark the corners of the rectangle (from the drawing) on the ground around the pond and chain or pace its length and width. For example, a length of 350 paces and a width of 125 paces would be equal to 896 feet (350 paces x 2.56 feet/pace [pace length, from above]) by 320 feet.
4. Multiply the length times width (see example above) to get the

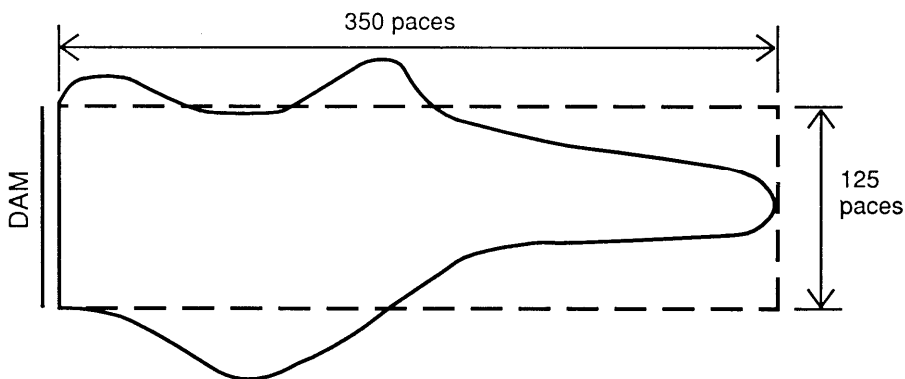

Figure 2. See instructions on how to calculate an irregularly shaped pond.

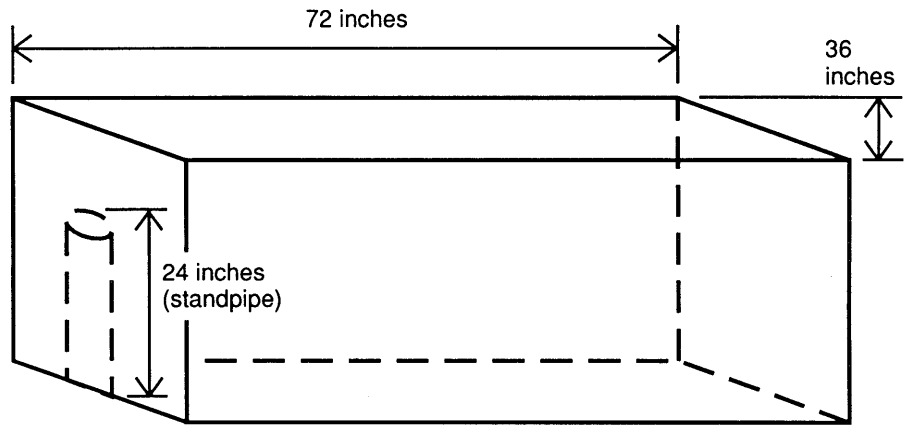

Figure 3. Figuring volume of a rectangular tank.

approximate pond area. For example, 896 feet x 320 feet = 286,720 square feet or 6.58 acres (286,720 ÷ 43,560).

It is a good idea to repeat this procedure two or three times and compare your results. You may want to average these results if they differ.

If a single rectangle does not fit the pond drawing then try to fit some combination of rectangles, circles, and/or triangles. If some combination seems to fit, then calculate the areas of the different shapes, and add the corresponding areas together to get the total pond area.

Calculating volume

Volume measurements are needed to calculate the proper concentration of most chemicals which are

applied to water and to calculate holding or transport densities.

Tanks

Most tanks used for holding and transporting fish are rectangular. Rectangular volume is calculated by the formula:

$$\text{Volume} = \text{length} \times \text{width} \times \text{depth}$$

When measuring a tank, take inside measurements of length and width and the depth at the appropriate water level. If a standpipe or other type of overflow drain is present then the height to the overflow should be the depth measurement. If the bottom of the tank is sloped toward the drain an average depth measurement should be used. To get average depth of the tank take three measurements: at the shallow end, in the middle, and at the overflow. Add these depths together and divide the total by 3.

For example, a rectangular tank, without a sloping bottom (see Figure 3 above), has a measured inside width of 36 inches, a length of 72 inches and a depth at the standpipe overflow of 24 inches. The calculated volume is 62,208 cubic inches (36 x 72 x 24).

In many cases it will be necessary to convert cubic inches (in³) to either cubic feet (ft³) or gallons. Table 4 gives simple ways to make these conversions. Cubic inches are converted to cubic feet by mul-

tipling by 0.000579 (or by dividing by 1728). Cubic inches are converted to gallons by multiplying by 0.00433 (or by dividing by 231). A volume of 62,208 in³ is the same as 36 ft³ (62,208 x 0.000579 or 62,208 ÷ 1728) and 269 gallons (62,208 x 0.00433 or 62,208 ÷ 231).

Circular tank volume (Figure 4) is determined by the formula:

$$\text{Volume} = 3.14 \times \text{radius}^2 \times \text{depth}$$

The radius is measured as 1/2 the inside diameter of the tank. The radius is squared or multiplied by itself. For example, a circular tank with an inside diameter of 72 inches and a standpipe depth of 24 inches has a volume of 97,667 cubic inches (3.14 x 36x36x 24).

Using Table 4 the volume can be converted into cubic feet (97,666.56 ÷ 1728 = 56.52) or gallons (97,666.56 ÷ 231= 422.8).

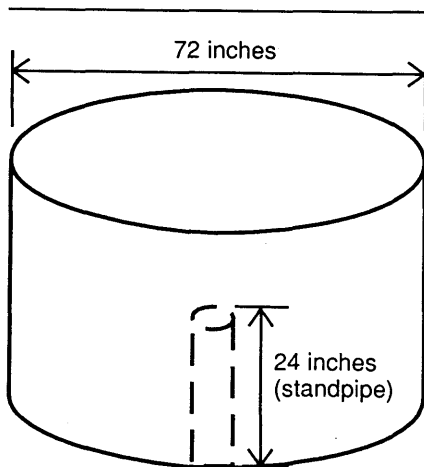

Figure 4. Circular tank volume.

Ponds

Pond volumes can be calculated using the formula:

$$\text{Volume} = \text{surface area} \times \text{average depth}$$

Calculating surface area was presented in the first section of this fact sheet. Calculate the average depth by measuring the depth at intervals around the pond. A boat and weighted cord (marked in feet) are used to take depth measurements. Measurements can be

done in a grid pattern or in a criss-cross pattern.

The number of depth measurements taken affects the accuracy of the estimate. Increasing the number of measurements increases the accuracy, so take as many measurements as possible.

Record all depth measurements, add them together and divide the total by the number of measurements taken. For example, in Figure 5, the sum of the depth measurements totals 93 feet. Divide 93 by 16 (the number of measurements) to get an average depth of 5.8 feet. The pond volume in this example (taking the surface area as 6.58 acres from previous example) would be 38.16 acre-feet (6.58 acres x 5.8 feet).

An alternative but accurate method to calculate pond volume is by adding salt and testing for chloride. This method is based on the fact that 1 acre-foot of water weighs 2.71 millions pounds and, therefore, 2.71 pounds of active ingredient dissolved in 1 acre-foot of water gives a solution of 1 part per million (ppm) or 1 milligram per liter (mg/l). If 2.71 pounds of salt are added to a pond of exactly 1 acre-foot, then the sodium chloride concentration will increase by 1 ppm. To determine volume by this method requires a chlorine test kit and uses the following procedure.

1. Test a pond water sample for chloride. Record this concentra-

tion. As an example, a pond with a surface area of 4 acres tests 0.1 mg/1 of chloride.

2. Broadcast 50 pounds of salt per surface acre of the pond; record the total pounds of salt added. In this example, broadcast 200 pounds of salt (4 acres).
3. Wait at least one day to allow the salt to dissolve and distribute evenly.
4. Take several water samples from different areas and depths (Figure 5) and test them for chloride concentration. In this example, six samples tested 8.1, 8.3, 8.9, 8.2, 8.5, and 8.6 mg/1 of chloride.
5. Calculate the average chloride concentration by adding all the concentrations together and dividing by the number of samples. In this example, average concentration = 8.43 mg/1.
6. Calculate the change in chloride concentration by subtracting the beginning concentration from the average concentration after salt treatment. In this example, 8.43 - 0.1 = 8.33 mg/1 is the change in chloride concentration.
7. Calculate the pond volume using the formula:

$$\text{Volume} = \frac{(\text{weight of salt applied} \times 0.6) + 2.71 \text{ (acre-ft)}}{\text{change in chloride concentration}}$$

In this example, (200 x 0.6 ÷ 2.71) ÷ 8.33 = 14.77 acre-feet.

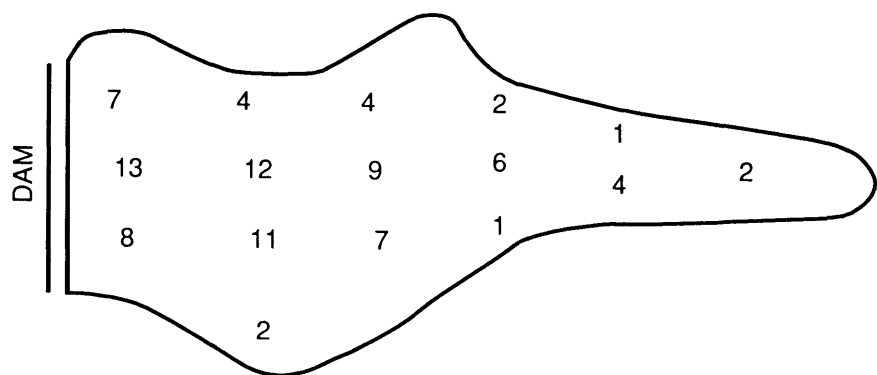

Figure 5. Example of pond depth measurements taken in a grid pattern.

The 0.6 in the formula is the proportion of chloride in sodium chloride (NaCl),

Measure chloride accurately and double-check your calculations! As a word of caution, this method will **not** work in deep ponds that are thermally stratified.

Keep good records of your pond area(s) and volume(s). Do not rely on your memory. The water level and volume in watershed ponds may vary from season to season with rainfall, evaporation, siltation and other factors. Pond managers should calculate the volume of ponds at different water levels, so

chemical treatments can be applied properly under any condition.

Do not guess the area or volume of your pond because the consequences could be costly.

Conversion Tables

| TABLE 1. Useful Conversion Factors (volumes refer to water). | |
|--|---|
| 1 acre | = 43,560 square feet = 4,840 square yards (circular) = 235.4 feet (diameter) (square) = 208,71 feet/side |
| 1 acre-foot (1 acre–1 foot deep) | = 43,560 cubic feet = 325,850 gallons = 2,718,144 pounds |
| 1 cubic foot | = 7.48 gallons = 1,728 cubic inches = 62.43 pounds |
| 1 gallon | = 8.34 pounds |
| 1 quart | = 4 cups = 32 fluid ounces |
| 1 pint | = 2 cups = 16 fluid ounces |
| 1 cup | = 8 fluid ounces = 8.344 ounces |
| 1 fluid ounce | = 1.043 ounces |

| TABLE 2. Conversions in Length. | | | | | |
|---------------------------------|-------------|-----------|-----------|-----------------|-----------|
| From | To | | | | |
| | inches (in) | feet (ft) | yard (yd) | centimeter (cm) | meter (m) |
| in | 1 | 0.0833 | 0.0278 | 2.540 | 0.0254 |
| ft | 12 | 1 | 0.3333 | 30.48 | 0.3048 |
| yd | 36 | 3 | 1 | 91.44 | 0.9144 |
| cm | 0.3937 | 0.0328 | 0.0109 | 1 | 100 |
| m | 39.37 | 3.281 | 1.0936 | 100 | 1 |

| From | To | | | |
|------|---------------|---------------|-------------|------------------|
| | ounce (oz) | pound (lb) | gram (g) | kilogram (kg) |
| oz | 1 | 0.0625 | 28.35 | 0.0284 |
| lb | 16 | 1 | 453.6 | 0.4536 |
| g | 0.0353 | 0.0022 | 1 | 0.001 |
| kg | 35.27 | 2.205 | 1000 | 1 |

| From | To | | | | | | |
|------------------|-----------------|-----------------|--------|----------|------------------|--------|----------------|
| | in ³ | ft ³ | fl oz | gal | c m ³ | l | m ³ |
| in ³ | 1 | 0,000579 | 0.5541 | 0.00433 | 16.39 | 0.0164 | 0.00001 |
| ft ³ | 1,728 | 1 | 957,5 | 7.481 | 0.000283 | 28.32 | 0.0283 |
| fl oz | 1.805 | 0.00104 | 1 | 0.0078 | 29.57 | 0,0296 | 0.00002 |
| gal | 231.0 | 0.1337 | 128 | 1 | 3,785 | 3.785 | 0.0038 |
| c m ³ | 0.0610 | 0.0000353 | 0.0338 | 0.000264 | 1 | 0.001 | 0.000001 |
| l | 60.98 | 0.0353 | 33.81 | 0.2642 | 1.000 | 1 | 0.001 |
| m ³ | 610,000 | 5.31 | 33,800 | 264.2 | 1,000,000 | 1,000 | 1 |

in³ = cubic inches; ft³ = cubic feet; fl oz = fluid ounce; gal = gallon; cm³ = cubic centimeter; milliliter = ml; l = liter; m³ = cubic meter.

| Amount active ingredient | Unit of volume | Parts per million |
|--------------------------|------------------|-------------------|
| 2.71 pounds | acre-foot | 1 ppm |
| 1.235 grams | acre-foot | 1 ppm |
| 1.24 kilograms | acre-foot | 1 ppm |
| 0.0283 grams | cubic foot | 1 ppm |
| 1 milligram | liter | 1 ppm |
| 8.34 pounds | million gallons | 1 ppm |
| 1 gram | cubic meter | 1 ppm |
| 0.0038 grams | gallon | 1 ppm |
| 3.8 grams | thousand gallons | 1 ppm |

TABLE 6. Conversion for parts per Million in proportion and percent.

| Parts per million | Proportion | Percent |
|-------------------|--------------|---------|
| 0.1 | 1:10,000,000 | 0.00001 |
| 0.5 | 1:2,000,000 | 0.00005 |
| 1.0 | 1:1,000,000 | 0.0001 |
| 2.0 | 1:500,000 | 0.0002 |
| 3.0 | 1:333,333 | 0.0003 |
| 5.0 | 1:200,000 | 0.0005 |
| 7.0 | 1:142,857 | 0.0007 |
| 10.0 | 1:100,000 | 0.001 |
| 15.0 | 1:66,667 | 0.0015 |
| 25.0 | 1:40,000 | 0.0025 |
| 50.0 | 1:20,000 | 0.005 |
| 100.0 | 1:10,000 | 0.01 |
| 200.0 | 1:5,000 | 0.02 |
| 250.0 | 1:4,000 | 0.025 |
| 500.0 | 1:2,000 | 0.05 |
| 1,550.0 | 1:645 | 0.155 |
| 5,000.0 | 1:200 | 0.5 |
| 10,000.0 | 1:100 | 1.0 |

The work reported in this publication was supported in part by the Southern Regional Aquaculture Center through Grant No. 89-38500-4516 from the United States Department of Agriculture.